

**Royal Modular 2.0**  
**800210110005000 Mirror cabinet**

**PRODUCT**

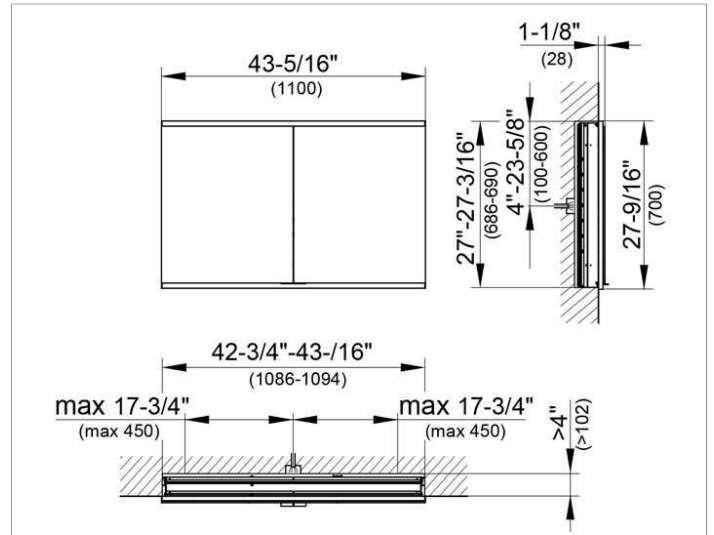

**DRAWING**



EEK: A++, A+, A,

**SURFACE**

silver anodized

**DIMENSION**

43,31 x 27,56 x 4,72 "

**Warranty:** KEUCO products are covered by a 5-year manufacturer's warranty, in effect from the date of purchase. During this time, proven product defects will be remedied free of charge. Warranty claims must be filed in writing, including a detailed description of the defect immediately after a defect has occurred. For a copy of our detailed product warranty policy, please contact us at [office-usa@keuco.com](mailto:office-usa@keuco.com).

**Installation:** KEUCO products must be installed by a qualified professional in accordance with the respective installation guidelines and any applicable federal / local building codes and regulations.